

***Enhanced 10/100Base-TX
to
100Base-FX Converter***

NXF-742 Series



Operation Manual

COPYRIGHT

All rights reserved. No part of this publication may be reproduced, stored in a retrieval system, or transmitted in any form or by any means, whether electronic, mechanical, photo copying, recording or otherwise, without the prior written permission of the publisher.

FCC WARNING



This equipment has been tested and found to comply with the limits for a class A device, pursuant to part 15 of FCC rules. These limits are designed to provide reasonable protection against harmful interference in a commercial installation. This equipment generates, uses and can radiate radio frequency energy and, if not installed and used in accordance with the instructions, may cause harmful interference to radio communication. Operation of this equipment in a residential area is likely to cause harmful interference, in which case, the user will be required to correct the interference at the user's own expense.



CE

This is a Class A product. In a domestic environment, this product may cause radio interference in which case the user may be required to take adequate measures.

Take special care to read and understand all content given in the warning boxes:



Warning

Table of Contents

1 Introduction	1
About This Guide	1
Welcome	1
Purpose	1
Terms/Usage	1
Features	2
Specifications	3
Package Contents	4
2 Hardware Description	5
Product Overview	5
3 Installation	8
Location	8
DIP Switches	9
NWay DIP Switch Setting	10
Link Fault Signaling (LFS)	12
Loopback Test	13
Local Loopback	14
Remote Loopback	15
Install the converter	16
10/100BASE-TX Port	16
100BASE-FX Port	16
Desktop Installation	17
Getting Connected	18
Powering On Unit	18
Connecting Fiber Cable	19
Connecting Copper Cable	20
4 LED Indicators	21
Appendix A	23

Cables.....	23
Appendix B	24
About RJ-45 Cables.....	24
Appendix C	25
Mini Converter Chassis.....	25
Features.....	25
Affixing Brackets	26
Installing the Converter.....	27
Rear view of Chassis and specifications	28
Rear View of Chassis with AC Power Supply ..	28
Rear View of Chassis with DC Power Supply ..	28
Appendix D	29
Application Diagrams.....	29
Application Diagram I.....	29
Application Diagram II.....	30
Application Diagram III.....	30

1 Introduction

About This Guide

Welcome

Thank you for choosing the Enhanced 10/100Base-TX to 100Base-FX Media Converter. This device integrates copper and multi-mode / single mode fiber networks in one flexible package.

Purpose

This guide discusses how to set up and install your Enhanced 10/100Base-TX to 100Base-FX Converter.

Terms/Usage

In this guide, the term “Converter” (first letter upper case) refers to your Enhanced 10/100Base-TX to 100Base-FX Converter, and “converter” (first letter lower case) refers to other converters.

Features

- Automatic MDI/MDI-X selection on RJ-45 port
- Link Fault Signaling (LFS)
- Store-and-forward at full wire speed
- Auto-negotiation, NWay support
- Half/Full duplex mode selection
- Remote and local loopback Test via DIP switch
- When DIP switches are set, the system auto-reboots to new configurations without powering-off.
- Extends distance of up to 2km (6600 feet) multi-mode fiber and 60km (198000 feet) long-haul single mode fiber
- Compatible with other 10Base-T & 100Base-TX /FX devices
- LEDs for at-a-glance device status
- Suitable as stand-alone or in 19" 4/12-slot rack-mount converter chassis or the single slot mini chassis (with internal power supply)
- FCC Class A & CE approved

Specifications

Standard: IEEE 802.3 (10BASE-T Ethernet),
IEEE 802.3u (100BASE-TX/FX Fast Ethernet)

Connector: 1x duplex fiber optic connector:
ST / SC types **or**
1x simplex fiber optic connector:
WDM single fiber types
1x UTP 100/120ohm; RJ-45 type

Max. Distance: **UTP:** 100m Cat 3/4/5

Fiber Optic:

2km MM, dual fiber

60km Long-haul SM, dual fiber

20km (66000ft) SM, single fiber

40km Long-haul SM, single fiber

Power: External power supply: 12V DC @ 0.8A
Please see Appendix A for Internal Power Supply

Temperature: Operating: 0 °C to 50 °C

Enhanced 10/100Base-TX to 100Base-FX Converter

	Storage:	-20 °C to 70°C
Humidity:	Operating:	10% to 80%RH
	Storage:	5% to 90%RH
Emissions:	FCC Part 15 of Class A & CE approved	
Dimensions:	109.2x 73.8x 23.4 mm (L x W x H)	
Switches for:	DIP 1	- Auto-negotiation (RJ-45)
	DIP 2	- Copper port duplex mode
	DIP 3	- Copper port data bit rate
	DIP 4	- Fiber port duplex mode
	DIP 5	- Link Fault Signaling (LFS)
	DIP 6	- Local Loop Back (LLB)
	DIP 7	- Remote Loop Back (RLB)

Package Contents

- One converter unit
- One AC adapter (please check connector type)
- Self-adhesive pads (4 pieces)
- User's Manual

2 Hardware Description

Product Overview

The Converter is enhanced with Link Fault Signaling (LFS) and Loopback Test (LBK) functions to offer the most comprehensive network status monitoring and connection diagnostics. It is designed for large workgroups who demand higher speed and wider bandwidth. It allows migration and expansion from a copper-based Ethernet to a fiber optic Fast Ethernet.

It features automatic MDI detection setting. This function allows for simple direct connection to a workstation, switch or hub. Therefore, network managers no longer need to worry about cable type configuration when establishing a connection between RJ-45 ports.

This Converter is equipped with an RJ-45 port and a fiber optic ST or SC or WDM port. This allows it to quickly integrate a 10/100Base-TX network into a 100Base-FX (fiber) network.

Enhanced 10/100Base-TX to 100Base-FX Converter

It features DIP switches for manual half or full duplex mode configuration on both copper and fiber ports. In full duplex mode, this Converter has the ability to support distances of up to 2 kilometers for multi-mode fiber and up to 60 kilometers for long-haul single mode fiber between a LAN switch, file server or another networking device.

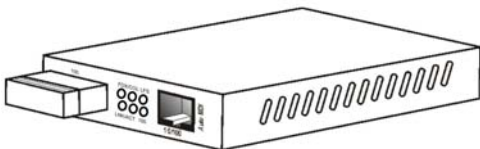

Converter with SC and RJ-45 Connectors

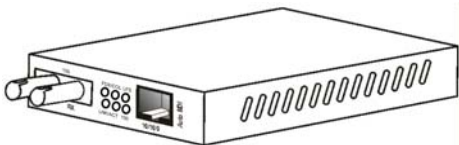

Converter with ST and RJ-45 Connectors

Front Panel View

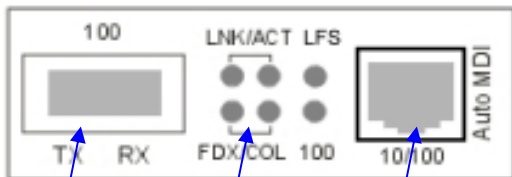

Fiber
Port

LED
Indicators

Copper
Port

3 Installation

To install your Converter, please see the following procedures:

- Location
- Switch Settings
- NWay settings
- Link Fault Signaling
- Loopback Test
- Install the Converter

Location

The location selected to install the Converter may greatly affect its performance. When selecting a site, we recommend considering the following rules:

- Install the Converter in a fairly cool and dry place. See Technical Specifications for the acceptable temperature and humidity operating ranges.
- Install the Converter in a location free from strong electromagnetic field generators (such as motors), vibration, dust, and direct exposure to sunlight.
- Leave at least 10cm of space at the front and rear of the unit for ventilation.
- Affix the provided rubber pads to the bottom of the Converter to protect the case from scratching.

DIP Switches

- DIP 1 Enables / disables auto-negotiation (RJ-45)
- DIP 2 Copper port (RJ-45) duplex mode: full or half-duplex
- DIP 3 Copper port (RJ-45) data bit rate: 10Mbps or 100Mbps
- DIP 4 Fiber port duplex mode: full duplex or half-duplex
- DIP 5 Enables / disables Link Fault Signaling (LFS)
- DIP 6 Enables / disables Local Loop Back (LLB)
- DIP 7 Enables / disables Remote Loop Back (RLB)

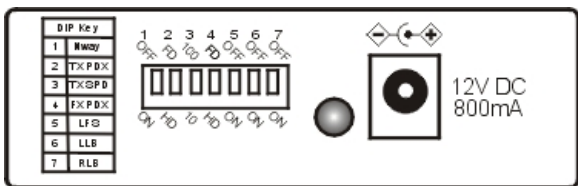

Notes: All models in this series feature the above set of DIP switches.

NWay DIP Switch Setting

Use the NWay DIP switch to activate NWay operations.

Factory NWay DIP switch default set to ON position. Check that the networking device to be connected to the Converter has NWay support.

If **YES**: Check that the NWay DIP switch is set to the ON position. The Converter will automatically set the optimum speed and duplex mode on the copper segment. Users can skip the settings for DIP switches 2 and 3, when NWay is activated.

If **NO**: Set the NWay DIP switch to the OFF position. Then Use **DIP switch 2** to manually select between half (HD) and full duplex (FD) modes. Use **DIP switch 3** to manually select between 10Mbps or 100Mbps speeds. Set NWay switch to OFF position when connecting to an auto-sensing device that only supports 10/100Mbps detection. Some early switch models only support auto-sensing of speed, and NOT auto detection of speed and duplex mode (auto-negotiation).

Important



In order to configure DIP switches 2 (duplex mode) and 3 (speed), you must set DIP switch 1 (NWay) to the OFF position

NWay DIP Switch Setting continue

Setting the duplex mode is feasible while the media converter is “on-line”

Note: If you experience the following problems, please check if the NWay switch is properly set.

1. The LNK (link) LED is not lit and the connection cannot be established
2. The LNK LED is lit and the connection is ok, but cannot transmit or receive data
3. The converter functions properly for a while, then, it does not work. And then it works after powering off and then on again.

Link Fault Signaling (LFS)

LFS is a “nice to have” function that is extremely beneficial in terms of network status monitoring. The LFS LED will immediately light to indicate when a cable has been severed or when some other cause of disruption in service has occurred. The LFS function monitors both copper and fiber segments giving a total connection status report.

Set LFS to **ON** position for normal operational use.

Set LFS to **OFF** position when installing cables or when testing the network connection.

Note: The LFS feature influences both fiber and copper segments. Therefore, when disruption occurs on either segment, the LFS feature will be activated and the LED will light to indicate that the entire connection is down.

To appreciate the full benefits of LFS, four converters can be used to build a primary and a secondary link. They must be connected to a switch that supports Spanning Tree or Fast Spanning Tree protocols. By default, transmission of data will travel via the primary link. Once a fault has been detected, transmission will automatically be switched to the secondary link, resulting in ‘non-stop’ network connectivity.

Loopback Test

This Converter features DIP switches to activate both local and remote loopback diagnostic test functions. Use local loop back to check if the copper segment is connected properly, and use remote loop back to check if the fiber segment is connected properly. Please see Diagram below:

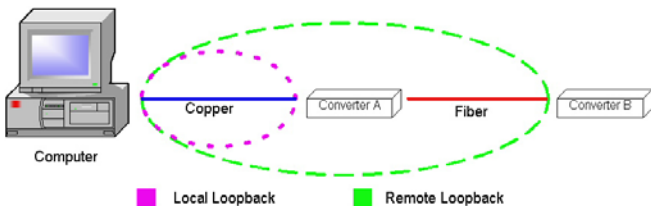

Dip Switch 6 ON: enables local loop back function

OFF: disables local loop back function

Dip Switch 7 ON: enables remote loop back function

OFF: disables remote loop back function

Make sure that the cables are connected properly before getting started. Conduct either the local or remote test, not both at the same time. Follow the steps below to perform the diagnostic tests.

Local Loopback

1. Test Condition setup – for the function to produce an accurate result, be sure to set switches according to the table below:

DIP Switches	1	2	3	4	5	6	7
Converter A	OFF	FD	100	FD	OFF	ON	OFF
Converter B	OFF	FD	100	FD	OFF	OFF	OFF

Test Condition

2. Launch a loopback or diagnostics testing program and follow the instructions given. Typically, the instructions will be similar to the following:
 - a. Enter the number of test messages (frame packets) to be sent (Between 1 – 1000)
 - b. Click on the START button
 - c. The program will send a testing message looped in the copper segment, and display a pass/fail result

Remote Loopback

1. Test Condition setup – In order for the function to produce an accurate result, set switches according to the table below:

Test Condition

DIP Switches	1	2	3	4	5	6	7
Converter A	OFF	FD	100	FD	OFF	OFF	OFF
Converter B	OFF	FD	100	FD	OFF	OFF	ON

2. Launch a loopback or diagnostics testing program and follow the instructions given. Typically, the instructions will be similar to the following:
 - a. Enter the number of test messages (frame packets) to be sent (Between 1 – 1000)
 - b. Click on the START button
 - c. The program will send a testing message looped in the fiber segment, and display a pass/fail result



Warning

Be sure to deactivate both local and remote both loopback test functions for normal converter operations

NOTE: On a PC, use a program such as Sniffer to conduct the tests. Other methods include the use of SmartBits series testing equipment. If you do not have access to either method, please contact your vendor for advice.

Install the converter

This Converter utilizes ports with fiber and copper port connectors functioning under Ethernet and/or Fast Ethernet protocols.

10/100BASE-TX Port

The 10/100BASE-TX port supports network speeds of either 10Mbps or 100Mbps, and can operate in half- and full duplex transfer modes. This port also offers automatic MDI/MDI-X crossover detection that gives true "plug and play" capability - just plug-in the network cable to the port and the port will adjust according to end node device automatically. The RJ-45 connector is suitable for UTP cable Category 3, 4, 5 or better.

100BASE-FX Port

The 100BASE-FX port adds a fiber Fast Ethernet link to your network device. Compliant with IEEE 802.3u, this port can transmits data at 100Mbps in full duplex mode across distances of up to 2km over multi-mode fiber-optic cable. The fiber port has a choice of three fiber connector types: ST, SC and WDM.

Desktop Installation

Follow the instructions listed below to install the Converter onto a desktop location.

1. Locate the Converter in a clean, flat and safe position that has easy access to AC power.
2. Affix the four (4) self-adhesive rubber pads to the underside of the Converter.
3. Apply AC power to the Converter. (The green PWR LED on the front panel should light).
4. Connect cables from the network partner devices to the ports on the front panel. (The green LNK LED on the front panel associated with the port should light).

This Converter can also be mounted on a vertical surface. Simply use the underside of the unit as a template to measure and mark out the position of the holes on to the surface where the unit is to be installed. Then use two screws to mount the converter firmly in place.



Warning

Please exercise caution when using power tools. Also, install this unit away from damp or wet locations, or in close proximity to very hot surfaces. These types of environments can have a detrimental effect on the converter and cables. An ideal location is a lightly cooled place such as a typical equipment room. Because invisible laser radiation may be emitted from the aperture of the port when no cable is connected, avoid exposure to laser radiation and do not stare into open apertures.

Getting Connected

Powering On Unit

The Converter uses an AC power supply 100~240V AC, 50~60 Hz. The Converter's power supply automatically self-adjusts to the local power source and may be powered on without having any or all LAN segment cables connected.

1. Insert the power cable plug directly into the receptacle located at the back of the device.
2. Plug the power adapter into an available socket.

Note: For International use, you may need to change the AC power adapter cord. You must use a power cord set that has been approved for the receptacle type and electrical current in your country.

3. Check the power LED on the rear of the Converter
4. When the device is powered on to verify that power is applied. If not, check that the power cable is correctly and securely plugged in.

Connecting Fiber Cable

When connecting fiber cable to a 100BASE-FX port on the Converter, be sure the correct type - ST or SC or WDM - connector is used. Follow the steps below to properly connect fiber cable:

1. Remove and keep the ST/SC/WDM port's rubber cover. When not connected to a fiber cable, the rubber cover should be replaced to protect the optics.
2. Check that the fiber terminators are clean. You can clean the cable plugs by wiping them gently with a clean tissue or cotton ball moistened with a little ethanol. Dirty fiber terminators on fiber optic cables will impair the quality of the light transmitted through the cable and lead to degraded performance on the port.
3. Connect one end of the cable to the ST/SC/WDM port on the Converter and the other end to the ST/SC/WDM port on the other device.

Note: When inserting the cable, be sure the tab on the plug clicks into position to ensure that it is properly seated.

5. Use DIP switch 4 to select between half and full duplex modes for the fiber port
6. Check the corresponding port LED on the Converter to make sure that the connection is valid. (Refer to the LED chart in next section)

Connecting Copper Cable

The 10/100BASE-TX RJ-45 Ethernet port fully supports auto-sensing and auto-negotiation.

1. Insert one end of a Category 3/4/5/5e type twisted pair cable into an available RJ-45 port on the Converter and the other end into the port of the network node.
2. Check the corresponding port LED on the Converter to be sure that the connection is valid. (Refer to LED chart in next section)

4 LED Indicators

This Converter has LED indicators located at the front of the device. The LEDs have been designed to give easy at-a-glance network status, and provides 'real-time' connectivity information. Please see below for an interpretation of their functions:

Unit LEDs		
LED	Condition	Status
PWR	On (Green)	Converter is receiving power
	Off	Power off or failure
LFS	On (Red)	Disruption of connection in copper/fiber segment
	Off	Copper/fiber segment is 'OK'

Port LEDs		
LED	Condition	Status
100	On (Green)	Port operating at 100Mbps
	Off	Port operating below 100Mbps
LNK/ACT	On (Green)	Illuminated when connectors are attached
	Flashing (Green)	Data traffic passing through port
	Off	No valid link established on port
FDX/COL	On (Amber)	Port is operating at full duplex
	Flashing (Amber)	Indicates collision
	Off	Port is operating at half-duplex

Appendix A

Cables

The following are some recommendations as to what you should and should not do when installing cables. Remember - cables are the deciding factor in network performs

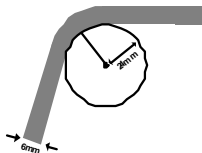

Try to maintain a bend radius of (min.) 4x the diameter of the cable for UTP and 100x for fiber.



Try not to allow the cable to twist too much - this creates a strain on the internal cables.



Place cable ties at regular intervals - do not over tighten cable ties - try to avoid using with fiber.



Do not stretch the cable especially on corners, in vertical cable trays and when spanning long distances.

Appendix B

About RJ-45 Cables

When connecting your network devices, use standard Category 3 eight-way cables for 10Base-T configurations and Category 5 cable for 100Base-TX.

The pin assignments are as follows:

Pin 1	TD+ Pair	2	White/Orange
Pin 2	TD- Pair	2	Orange/White
Pin 3	RX+ Pair	3	White/Green
Pin 4	N/A Pair	1	Blue/White
Pin 5	N/A Pair	1	White/Blue
Pin 6	RX- Pair	3	Green/White
Pin 7	N/A Pair	4	Brown/White
Pin 8	N/A Pair	4	Brown/White

Application	Cable Type	Application	
Converter to Converter or Network Adapter	Straight-through Cable	Converter End	Hub
		1 ←————→ 1 2 ←————→ 2 3 ←————→ 3 6 ←————→ 6	
Converter to Switch	Cross-Over Cable	Converter End #1	Converter End #2
		1 ←————→ 2 2 ←————→ 1 3 ←————→ 6 6 ←————→ 3	

Note: Automatic MDI/MDI-X selection on RJ-45 port

Appendix C

Mini Converter Chassis

The Chassis is developed to accommodate just one media converter. The Chassis provides AC or DC power protection for converter units. Now, network designers can plan their Ethernet, Fast Ethernet, ATM, or Gigabit networks without having to worry about the power source. Furthermore, its unique sizes allows it to be installed in locations where space is limited.

Features

- Simple and easy to install
- Adds fiber connectivity to otherwise copper based networks
- Supports 10/100/1000Base, copper, fiber, single/multi-mode, ST, SC, MT-RJ, VF-45, LC, WDM connector converters
- Supports one media converter
- Suitable for all size of networks in all locations
- Provides internal AC and DC switching power supply
- Made from high quality durable steel
- Optional external redundant power adapter

Affixing Brackets

We have supplied 2 special brackets that easily attaches to the Converter. This allows for the secure placement of the Converter into the Chassis. It also seals off the front of Chassis and allows it to function correctly.

- Step 1** Using a Phillips screwdriver; remove two screws from the side panels on the converter.



- Step 2** Place the converter and brackets on a flat horizontal surface as illustrated above. Secure the brackets by replacing the screws.



Ensure that the rails are flush-mounted with the underside of the Converter. The Converter is now ready for loading into the Chassis.

Installing the Converter

Once the Converter has been attached to the bracket, it can be installed into the Chassis. Special care must be taken to ensure the correct mating of the power connector. Align the Converter so that it fits between the upper and lower guide rails.

Warning Always ensure that the converter power socket is positioned at the base of the Chassis. Never force the Converter into the Chassis - check power socket position and alignment.

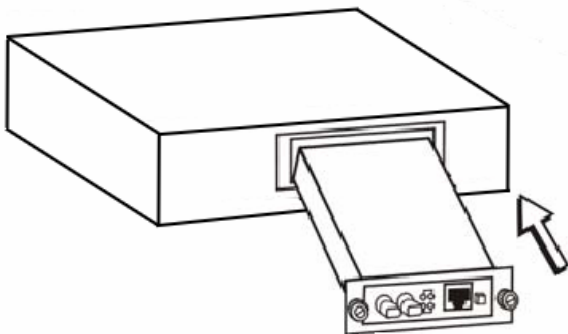

Rear view of Chassis and specifications



Rear View of Chassis with AC Power Supply

Power: 100 - 240V AC (Optional 12V Adapter)

Dimensions: 109 x 174 x 44.3 mm (L x W x H)



Rear View of Chassis with DC Power Supply

Power: -48V DC (Optional 12V Adapter)

Dimensions: 109 x 174 x 44.3 mm (L x W x H)

Appendix D

Application Diagrams

To effectively expanding a Fast Ethernet network, position two converters back-to-back as illustrated.

Application Diagram I

In the figure below, the Converter is functioning as a high-speed bridge between switches creating increased capacity for each user (node) on the local area network. It is providing a 100Mbps full duplex link to a variety of Fast Ethernet network devices within a LAN.

Switch ↔ CONVERTER ↔ CONVERTER ↔ Switch

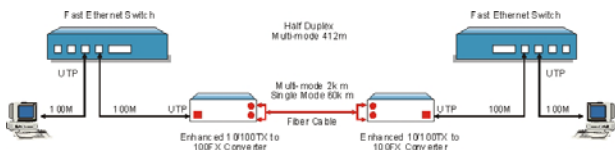

Application Diagram II

In the figure below, the Converter is functioning as a server aggregation for an enterprise or LAN configuration. It is providing a 100Mbps full duplex link to a workgroups of 10/100 switches located on separate floors within a single building.

Switch ↔ CONVERTER ↔ CONVERTER ↔ Server

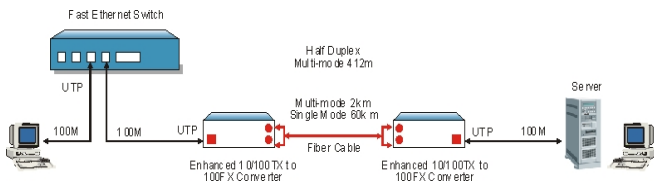

Application Diagram III

In the figure below, the Converter is functioning as a high-speed dedicated link within a campus network configuration. It is providing a 100Mbps full duplex link to a remote network node.

Switch ↔ CONVERTER ↔ CONVERTER ↔ Switch

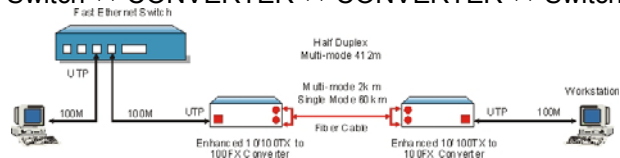

VOLKTEK CORPORATION

4F, No. 192 Lian-Cheng Road

Chung-Ho, Taipei 235, Taiwan ROC

TEL: +86 (2) 8242-1000

FAX: +886 (2) 8242-3333

Tech Support: +886 800-286-286

ISO 9001 Certified